

# FLOW SWITCH

# MODEL Q-12N Q-12CR Q-12DS POOL & SPA VERSION

Model Q-12 is provided with three factory adjustable parameters which provide performance flexibility to meet a multitude of applications:

- Paddle Area
- Paddle Length
- Paddle Stiffness

Max. flow may be five times normal flow.

Positive stop eliminates fatigue effects of turbulence, vibration and flow surge on flow detecting element.

Very low pressure drop - typically less than 1.0 psig at normal flow rate.

Small size and low profile provides easy mounting in crowded installations.

Power the driving coil of small ice cube relays as well as some 30A power relays.

Available with NO, NC or SPDT Reed Switch

Switches 5VDC to 240VAC.

Switch employs magnetic coupling.

Send us your special requirements. We will quote a special unit to meet those requirements.



## KEY FEATURES

Flow Range	<b>0.7-590 GPM (2.6-2,233 L/m)</b>
Working Temp	<b>200°F (93°C) Maximum</b>
Working Pressure	<b>250 psi (1.724 kPa)</b>
Process Connection	<b>½" NPT, ¾" NPT</b>
Electrical (Reed) Switch	<b>SPNO 0.5A*</b>
Enclosure	<b>NEMA 4X / IP 66</b>

\* Other models available

## TYPICAL USES

### Monitoring flow of coolant supplied to:

Brakes and Clutches	Emergency Wash-Down Showers
Computer Systems	Marine and Stationary Engines
Diodes, SCRs, Triacs, etc.	RF and Radar Transmitters
Electromagnets	Spot welders
Fire Sprinkler Flow Alarms	Transformers
Lasers	Vacuum Systems

### In Chemical Processing:

Fluid Blending Systems	Liquid Transfer
Heat Transfer Fluids	Monitor Filter Clogging
Liquid Scrubbers	Starting back-up pumps
Monitoring pump output, valve position, systems flow status	

### In Water Treatment:

Irrigation Systems	Salt and Fresh Water Systems
--------------------	------------------------------

## SIDE VIEW

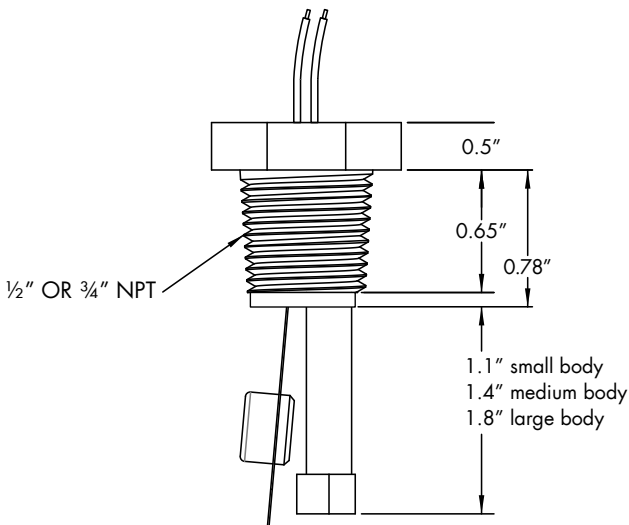

## ≈ TYPICAL WORKING FLUIDS

For use in a broad spectrum of industrial fluids, such as:

Cooling Tower Water	Water (saltwater, pure, tap, etc.)
Glycol Solutions	Lubricating Oils
Mild Acids	Gasoline
Plating Solutions	JP-4

## TOP VIEW

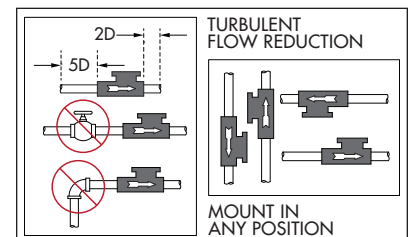
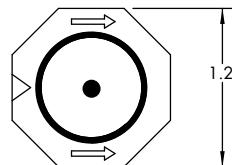

541 Kinetic Drive  
Oxnard, CA 93030  
www.harwil.com  
16.299

Phone: (805) 988-6800  
Fax: (805) 988-6804  
Email: harwil@harwil.com

MODEL SELECTION CHART			
Flow Range (Water calibrated at 70°F / 21°C) Accuracy ±10%			
PIPE SIZE NPT	NOMINAL ON/OFF SWITCH POINT RANGE (GPM)		PADDLE NUMBER
	ON	OFF	
¾"	0.9	0.8	3 (.7SM)*
	3	2	3SM
	11	10	6S
1"	1.1	1.0	3 (.7M)*
	4	3	4S
	6	5	6S
1½"	2.8	2.5	4 (.7L)*
	13	12	4S
	16	15	6M
	21	19	6S
2"	4.9	4.4	4 (.7L)*
	15	12	4M
	23	18	4S
	27	22	6M
3"	11.0	9.9	4 (.7L)*
	33	25	4M
	57	45	4S
	65	58	6M
	82	78	6S
4"	19.6	17.6	4 (.7L)*
	56	43	4M
	95	83	4S
	120	108	6M
	150	140	6S
5"	30.6	27.5	4 (.7L)*
	92	69	4M
	150	130	4S
	180	170	6M
	230	220	6S
6"	135	95	4M*
	220	180	4S
	260	220	6M
	340	310	6S

Call our customer support for a wider range of pipe sizes. (805) 988-6800  
 \* = Requires ¾ NPT process connection

### ELECTRICAL CONNECTION OPTIONS

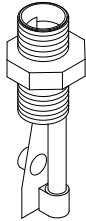

#### OPTION 1

BASIC UNIT SUPPLIED WITH TWO 0.187 x 0.020 MALE SPADE TERMINALS RECESSED IN ½" NPT NIPPLE SECTION.

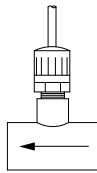

#### OPTION 2

BASIC UNIT WITH TWO-CONDUCTOR INSTRUMENT CABLE POTTED IN PLACE. PVC TEE OPTIONAL.

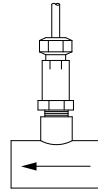

#### OPTION 3

BASIC UNIT W/ DMP TAPERED RUBBER GROMMET ATTACHMENT FOR WATERTIGHT SEAL & STRAIN RELIEF. PVC TEE OPTIONAL.

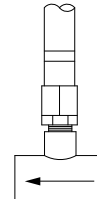

#### OPTION 4

BASIC UNIT WITH ½" FLEXIBLE SPIRADUCT PLASTIC CONDUIT & FITTINGS. ELECTRICAL CABLE NOT SUPPLIED. PVC TEE OPTIONAL.

# Q-12N Q-12CR

# Q-12DS POOL & SPA VERSION

### TECHNICAL SPECIFICATIONS

#### ELECTRICAL (REED) SWITCH CHARACTERISTICS

SPNO

Contact Ratings:	N50	C2
AC Voltage (max. switching)	300VAC	24-30
DC Voltage (max. switching)	350VDC	24-30
Current (max. switching)	0.5A	0.1A
Power (max) (VA, W)	50 watts	10 watts

OPTIONAL: SPNC or SPDT, 3 watt, 100VAC/VDC.

#### INDUCTIVE LOADS

Switch contacts have been tested with small relays and 30A J-C relay inductive driving coils at 120/240VAC to 500,000 operations without failure.

#### Q-12N (NORYL®)

**WORKING PRESSURE:** 200 psig max. @ 70°F

**WORKING TEMPERATURE:** 180°F @ ambient pressure

**WETTED MATERIALS:** Body: Noryl® (PPO) (10% glass fibers)  
 Paddle: 316 stainless steel Seal: Epoxy

#### Q-12CR (FORTRON®)

**WORKING PRESSURE:** 250 psig max. @ 70°F

**WORKING TEMPERATURE:** 200°F @ ambient pressure

**WETTED MATERIALS:** Body: Fortron® (PPS) (40% glass fibers)  
 Paddle: HASTELLOY® C. Seal: Epoxy

#### SAMPLE PART NUMBER

OPTION 1: Q-12N	/ ¾	/ SB	/ 4S	/ NO	/ 1
BASE MODEL	↑	↑	↑	↑	↑
PROCESS CONNECTION ½" or ¾" NPT					
PIPE SIZE: SB ¾" TO 1"; LB 1½"+					
PADDLE NUMBER					
SWITCH OPERATION (NO OR NC)					
ELECTRICAL CONNECTION OPTION					

Note: Tee and orifice options available when ordering.

NOTE: Model Q-12N employs magnetic coupling between bending blade and switch body. Magnetic particles can accumulate on and around magnetic housing which may affect proper operation. Please conduct appropriate fluid magnetic particle evaluation and operational tests prior to and during installation and use.

- Installation drawing and a numbered parts list is supplied with each unit.
- Special one-day delivery is available.