

MODEL Q-12

Q-12N, Q-12CR, Q-12DS (TEMPERATURE: QT-12)

HARWIL CORPORATION

541 KINETIC DRIVE, OXNARD, CA 93030

TEL: (805) 988-6800 FAX: (805) 988-6804

EMAIL: HARWIL@HARWIL.COM

INSTALLATION INSTRUCTION SHEET

SIDE VIEW

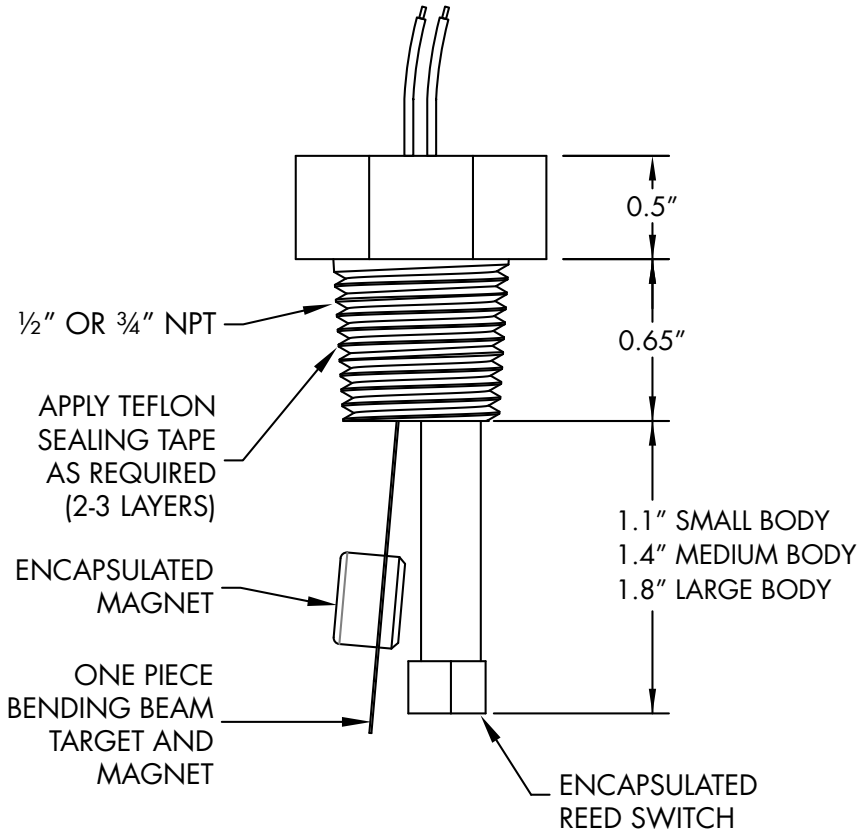

TOP VIEW

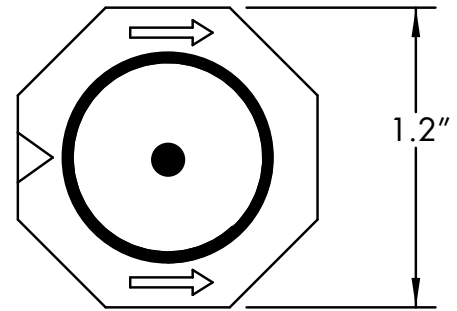

- Pressure drop typically less than 1.0 psi at rated flow.
- Mount in any position.

OPTION 3 GROMMET SELECTION CHART

Grommet Size	Cable OD	Grommet Size	Cable OD
A	0.25"	B	0.375"
AA	0.33"	C	0.50"

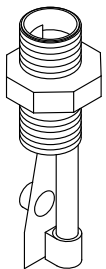

OPTION 1

BASIC UNIT SUPPLIED WITH TWO 0.187 x 0.020 MALE SPADE TERMINALS RECESSED IN 1/2" NPT NIPPLE SECTION.

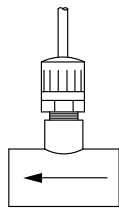

OPTION 2

BASIC UNIT WITH TWO-CONDUCTOR INSTRUMENT CABLE POTTED IN PLACE. PVC TEE OPTIONAL.

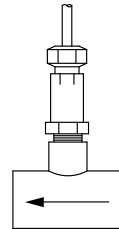

OPTION 3

BASIC UNIT W/ DMP TAPERED RUBBER GROMMET ATTACHMENT FOR WATERTIGHT SEAL & STRAIN RELIEF. PVC TEE OPTIONAL.

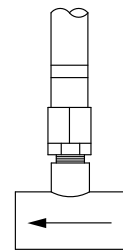

OPTION 4

BASIC UNIT WITH 1/2" FLEXIBLE SPIRADUCT PLASTIC CONDUIT & FITTINGS. ELECTRICAL CABLE NOT SUPPLIED. PVC TEE OPTIONAL.

FLUID FLOW SWITCH

ULTRA RELIABLE SINCE 1956

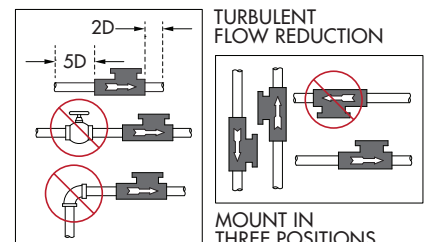

MODEL Q-12

Q-12N, Q-12CR, Q-12DS (TEMPERATURE: QT-12)

HARWIL CORPORATION

541 KINETIC DRIVE, OXNARD, CA 93030

TEL: (805) 988-6800 FAX: (805) 988-6804

EMAIL: HARWIL@HARWIL.COM

INSTALLATION INSTRUCTIONS

Flow switch should be mounted at least 5 pipe diameters downstream and 2 pipe diameters upstream of any source of turbulence, such as valves, elbows, reducers, etc.

1. Remove unit from shipping box and inspect it for possible damage (i.e., cracks, damaged threads, deformed bending beam, etc.)
2. Check model number on label with that shown on packing list vs. configuration actually received (return to supplier if discrepancy is found).
3. Place a multimeter or equivalent test meter across the two wire leads coming from the unit and check for proper switch operation by gently moving bending beam and magnetic assembly toward switch support tube. Switch should activate when separation is in the range $\frac{1}{8}$ " to $\frac{3}{16}$ ".
4. If no discrepancy is found, thread unit into appropriate tee.
5. Care must be exercised during threading operation to

insure threads are not crossed and the bending beam target assembly does not touch the inside surface of the tee.

NOTE: It may be necessary to test fit the unit in a tee identical to the tee mounted in the flow line to ensure adequate clearance during rotational insertion sequence. For black iron and galvanized tees, check for possible hang up of bending beam due to attraction of magnet to interior metal wall.

6. Tighten unit in tee until fluid leaks are eliminated, flow target is approximately centered along axis of pipe and flow direction arrows located on unit are aligned parallel with flow in pipe. When threading into PVC fittings 2-3 layers of Teflon sealing tape is recommended. Tighten 2-3 turns beyond finger tight.
7. Complete wiring to signal processor, light, relay, etc. per local code.

CAUTION INSTALLATION OR REMOVAL OF FLOW SWITCH FROM SMALL TEE

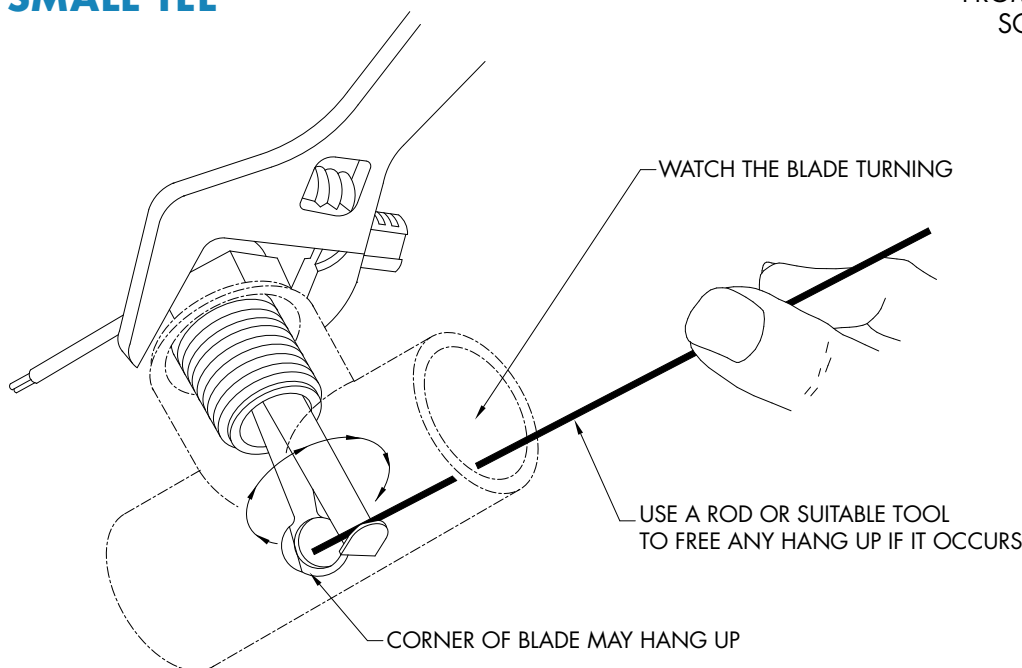

WIRING DIAGRAM

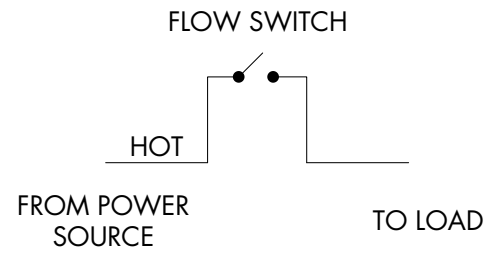

Temperature QT-12

A temperature sensor is included on the QT models. The wiring is Black-Red for the switch and Green-White for the temperature sensor.

CERTIFICATE OF CONFORMANCE

All Harwil Corporation ("HARWIL") products are manufactured using new materials and components. Our products meet the applicable performance and materials specifications indicated in our current Specifications Sheets and Parts List. HARWIL endeavors to obtain its materials and components from American Companies.

DOMINANCE OF HARWIL LIMITED EXPRESS WARRANTY

Each user **MUST** make appropriate analysis and tests to determine the suitability of the HARWIL product for the intended use prior to purchase.

HARWIL warrants that all HARWIL products will be free from defects in material and workmanship for a period of one year from the date of original shipment. This Warranty shall be LIMITED to the replacement and reconditioning of our products and parts. HARWIL reserves the right and sole discretion to modify or change the composition, design and appearance of its products at anytime.

THIS WARRANTY SHALL BE IN LIEU OF ALL WARRANTIES OF MERCHANTABILITY AND OF ALL WARRANTIES OF FITNESS FOR A PARTICULAR PURPOSE RELATING TO HARWIL PRODUCTS AND PARTS. BUYER'S SOLE REMEDY SHALL BE REPLACEMENT OR RECONDITIONING AS SET FORTH HEREIN.

HARWIL SHALL INCUR NO OBLIGATIONS HEREUNDER AND NO LIABILITY IN THE EVENT OF (1) BUYER NOT FULFILLING ITS RESPONSIBILITIES; INCLUDING AS SET FORTH HEREIN; (2) NEGLIGENCE, ALTERATION OR IMPROPER PRODUCT USE, INCLUDING USE WITH NON-COMPATIBLE DEVICES OR CHEMICALS; OR (3) REPAIR BY ANOTHER COMPANY OR PERSON THAN HARWIL.

ANY LAWSUIT RELATING TO THIS LIMITED EXPRESS WARRANTY MUST BE COMMENCED WITHIN ONE YEAR OF THE DATE THE LAWSUIT ACCRUES.

HARWIL provides NO WARRANTY and ASSUMES NO RESPONSIBILITY for corrosive attack on any material, component or design features associated with any of its products.

Corrosion resistance information listed in HARWIL specification sheets, information sheets and product brochures is solely for general background information. This information table has been compiled from literature published by various material suppliers and by equipment manufacturers who use these materials in their products. Inasmuch as these data are based on tests by entities over which HARWIL has no control, HARWIL DOES NOT GUARANTEE AND DOES NOT ACCEPT ANY RESPONSIBILITY FOR THE ACCURACY OF SUCH THIRD PARTY TESTING. When using the table, please remember that in any given case several factors such as concentration, temperature, degrees of agitation and presence of impurities influence the rate of corrosion. The information table is intended, in a general way, to rate materials for resistance to chemicals which contain their usual impurities and for types of equipment in common use. Ratings should be used only as a general tool to first approximation of your material requirements rather than as the final answer.

WHEN IN DOUBT, TEST MATERIALS BEFORE INSTALLATION.

AFTER INSTALLATION, FOLLOW UP WITH SCHEDULED PREVENTATIVE MAINTENANCE AND PERIODIC INSPECTION.